



# ROC-3

## Reverse Osmosis System Controller Documentation

**i controls inc.**

15916 SE 41st Place

Bellevue, WA 98006

ph (425) 577-8851

[www.icontrols.net](http://www.icontrols.net)

**Welcome.**

Thank you for purchasing an i controls controller.

The ROC-3 is a state-of-the-art RO system controller. The documentation that follows should allow you to successfully install and operate the controller. However, if you have any questions, please contact us at the number below.

As good as our controllers are, there's always room for improvement. If you have an experience, idea or input either positive or negative we'd love to hear from you.

Again, thanks for your purchase. Welcome to the community of i controls users.



David Spears

President,  
icontrols inc.  
www.icontrols.net  
ph 425.577.8851

david@icontrols.net

## Table of Contents

---

Description	Page
Specifications, Table 1 _____	4
Schematic, Figure 1 _____	5
Controller Overview, Figure 2_____	6
Controller Detail: CPU-3 _____	7
Controller Detail: TB-2_____	8
Conductivity Probe Installation, Figure 5 _____	9
Installation Instructions _____	10
Controller Programming: Accessing Hidden Menus, Figure 6 _____	11
Controller Programming: Program Selections, Table 2 _____	12
Controller Programming: Menu Navigation, Figure 7 _____	13
Controller Programming: Parameters Explained, Appendix A _____	14-15
Controller Fault Condition Displays _____	16
Controller Programming: Programming Interface Overview _____	17
Controller Programming: Programming Interface Overview _____	18

**Table 1. Specifications**
**Inputs**

Tank level switches	(2) Normally-Closed. <i>Can be used with a single level switch.</i>
Inlet pressure switch	Normally-Open.
Pretreat lockout switch	Normally-Open.
Controller Power	110/240 VAC, 60/50Hz
Permeate Conductivity	0-1500* PPM, 0-3000 $\mu$ s
Feed Conductivity ( <i>opt</i> )	0-3000* PPM, 0-6000 $\mu$ s

\*These ranges are provided with the standard conductivity cell constant of 0.75. Higher ranges can be attained by using a cell with a different constant.

**Output Relay Ratings**

Feed Solenoid	12A Resistive, 6A (Inductive). <i>Voltage is the same as motor/supply voltage.</i>
Flush Solenoid	12A Resistive, 6A (Inductive). <i>Voltage is the same as motor/supply voltage.</i>
Divert	12A Resistive, 6A (Inductive). <i>Voltage is the same as motor/supply voltage.</i>
Motor	30A Resistive, .75HP/110V, 1.5HP/220V.

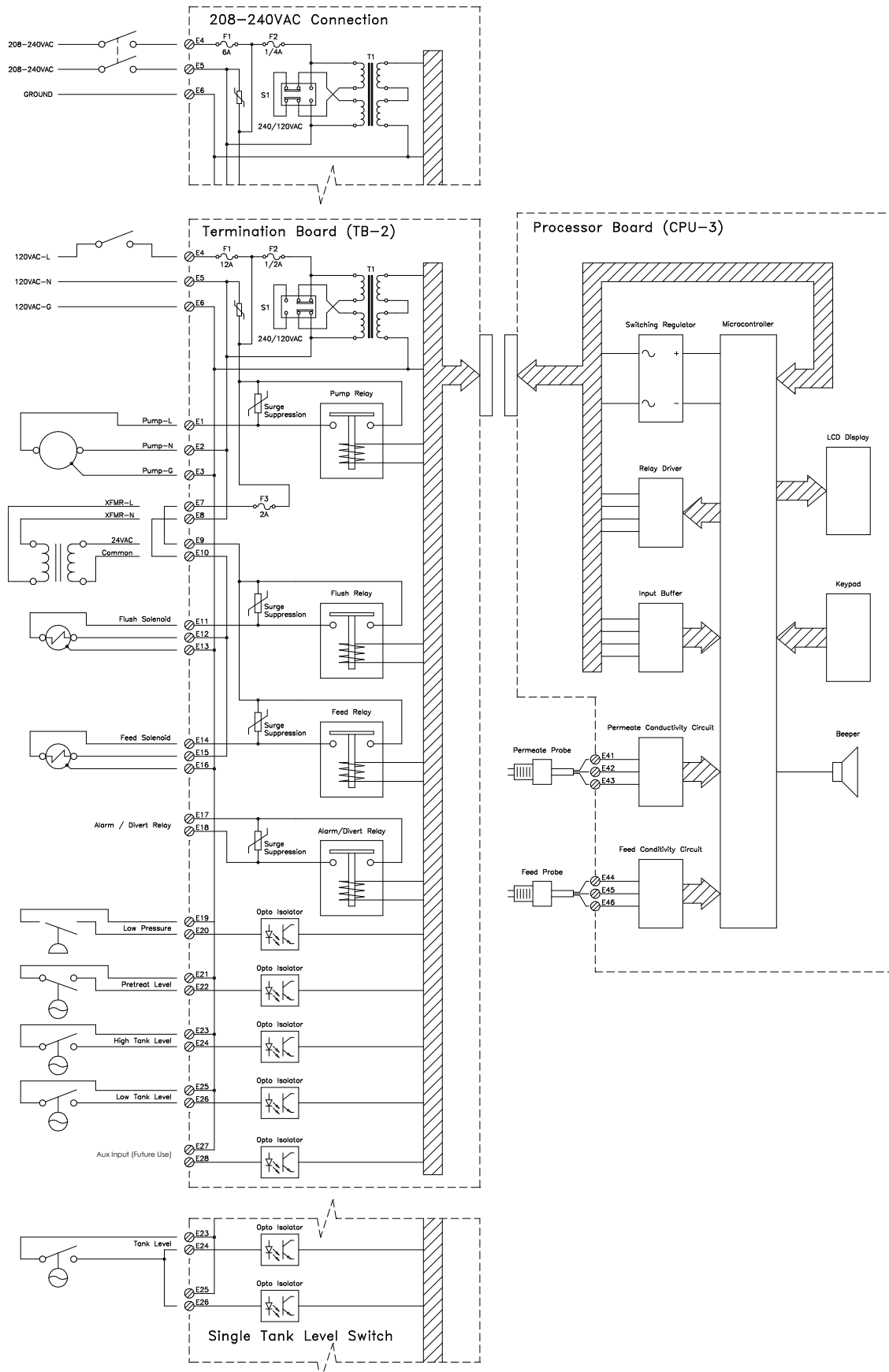
**Circuit Protection**

<b>Main Power Fuse (110V)</b>	F1 3AG 20 Amp	LittleFuse 314.O20(P) (For up to .75 HP motor)
<b>Main Power Fuse (208/240V)</b>	F1 3AG 12 Amp	LittleFuse 314.O12(P) (For up to 1.5HP)
<b>Transformer Fuse</b>	F2 3AG 1/8 Amp	LittleFuse 312.125(P)
<b>Relay Fuse</b>	F3 3AG 2 Amp	LittleFuse 312.OO2(P)

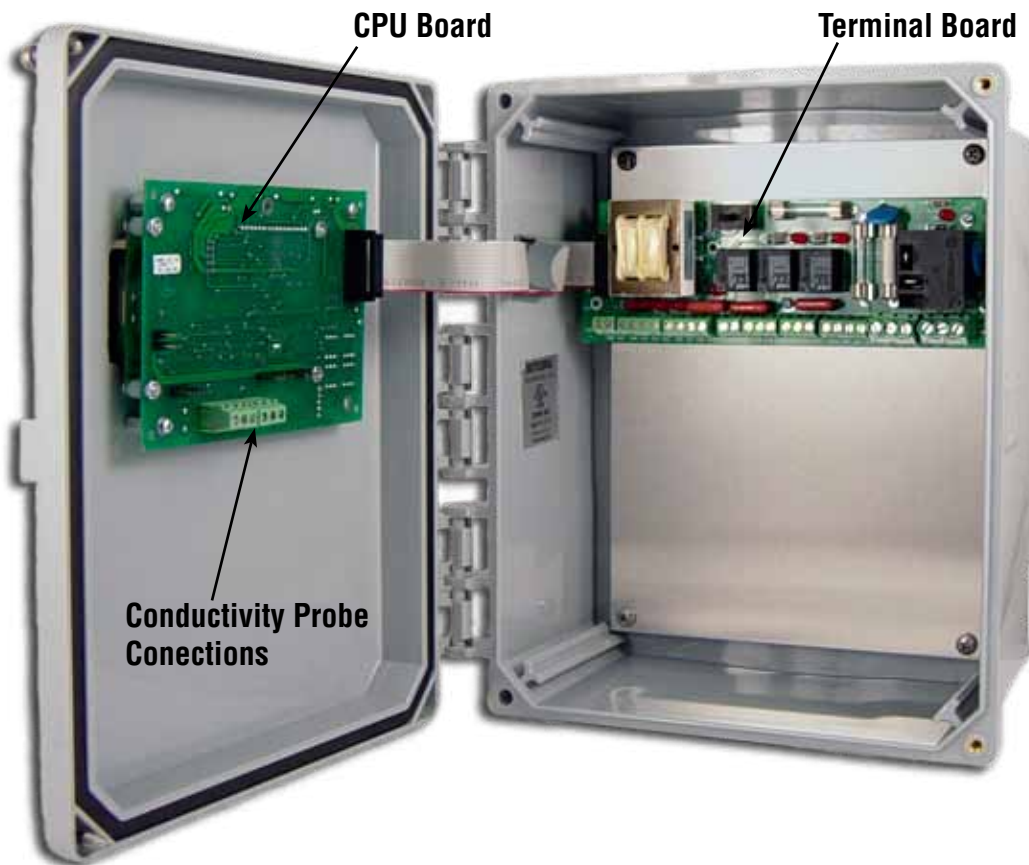
**Other**

Dimensions	10.5" tall, 9.5" wide, 5.0" deep. Nema 4X non-metallic (10x8x4)
	12.5" tall, 11.25" wide, 7.0" deep. Nema 4X non-metallic (12x10x6)
	14.5" tall, 13.5" wide, 7.0" deep. Nema 4X non-metallic (14x12x6)
Weight	4.2 lb. (10.5x9.5) ( <i>Enclosure, CPU-3 and TB-2 only.</i> )
	6.0 lb. (12.5 x 11.25) ( <i>Enclosure, CPU-3 and TB-2 only.</i> )
	10.6 lb. (12.5 x 11.25) ( <i>Enclosure, CPU-3 and TB-2 only.</i> )
Environment	0-50°C, 10-90%RH (non-condensing)

**Figure 1. Simplified Schematic**

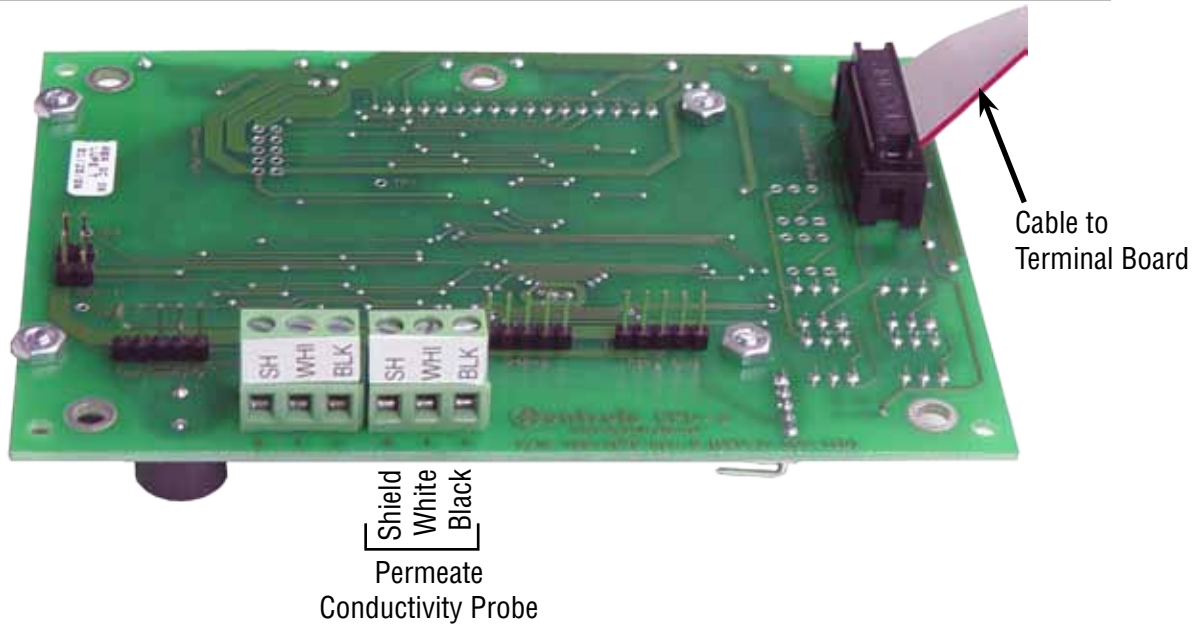


**Figure 2. Controller Overview**

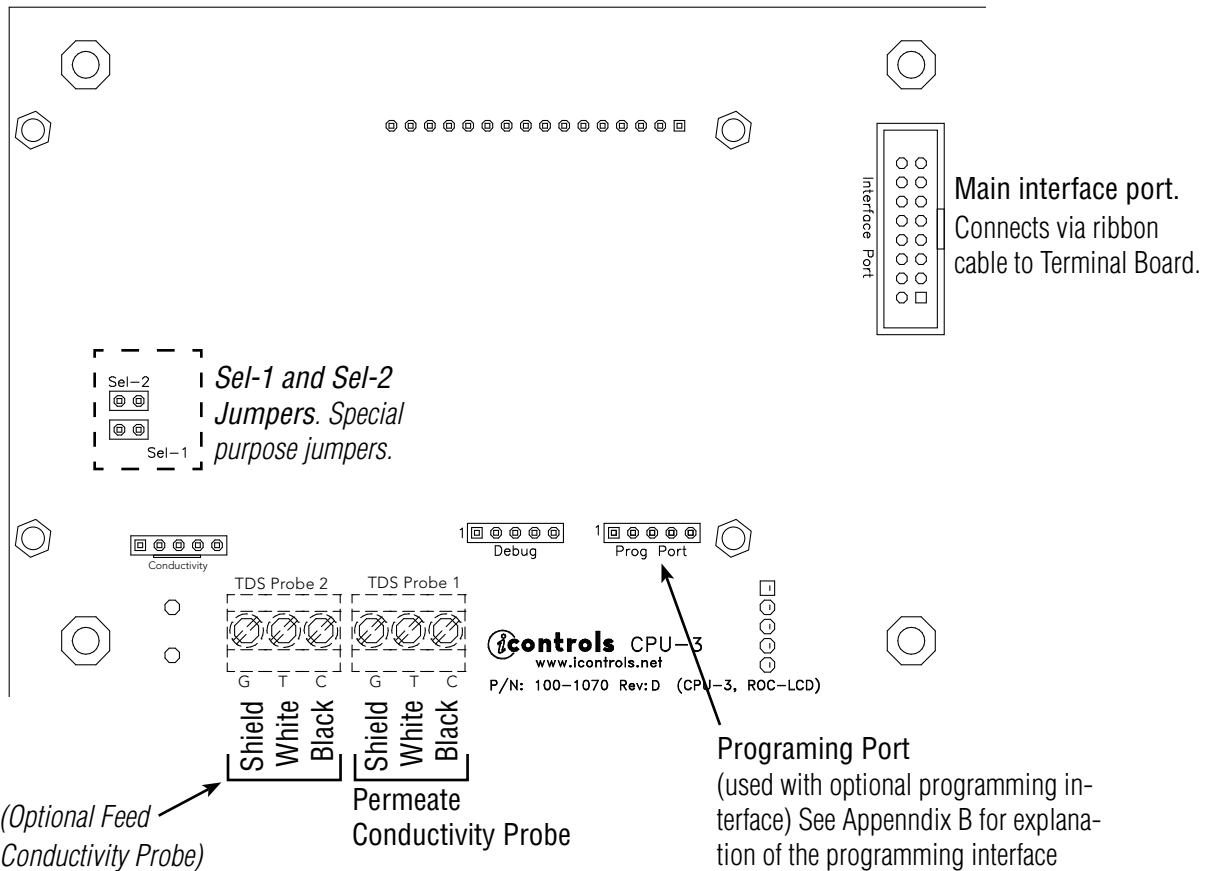


**Figure 3. Controller Detail: CPU-3**

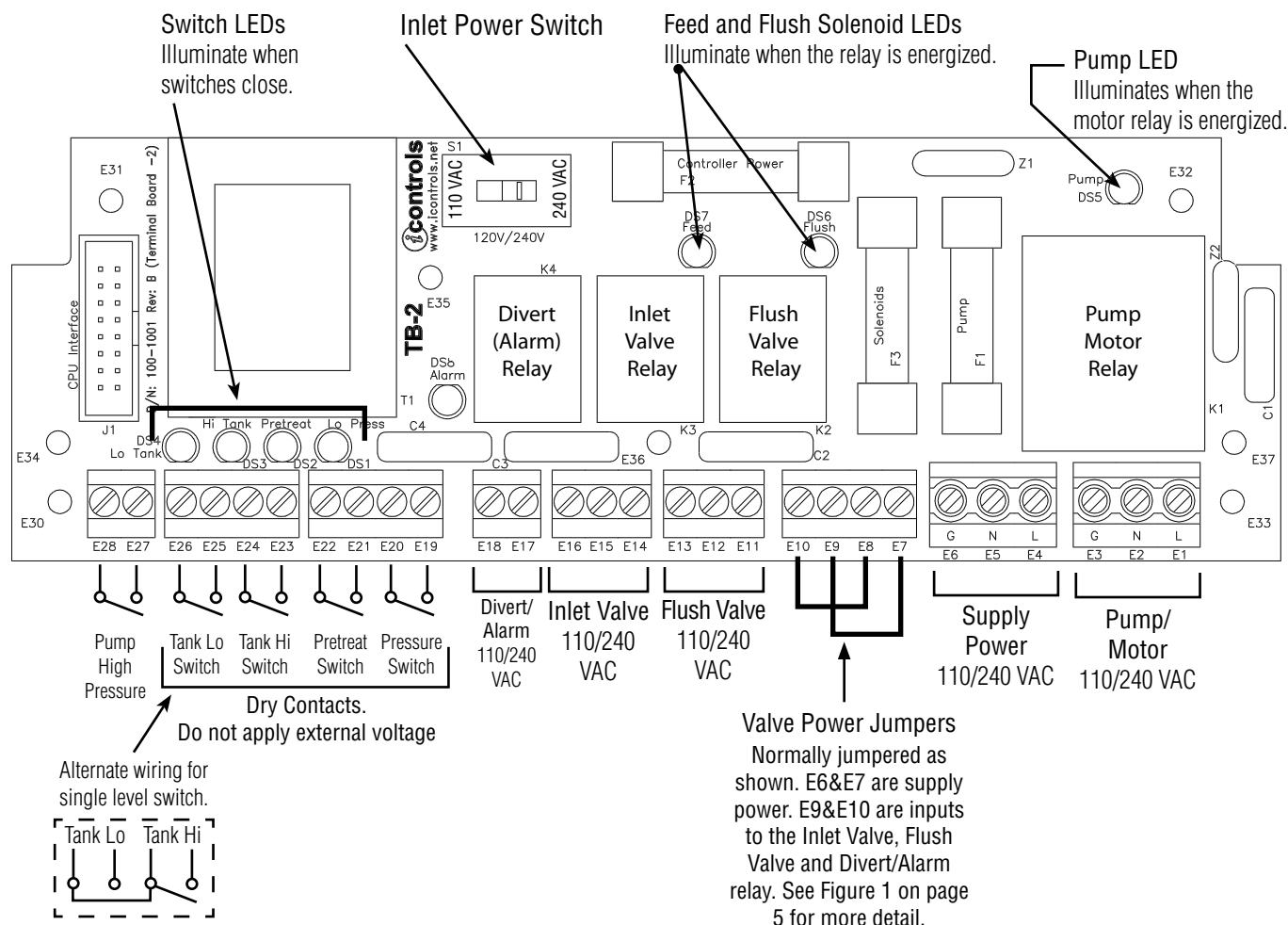
**Typical Configuration**

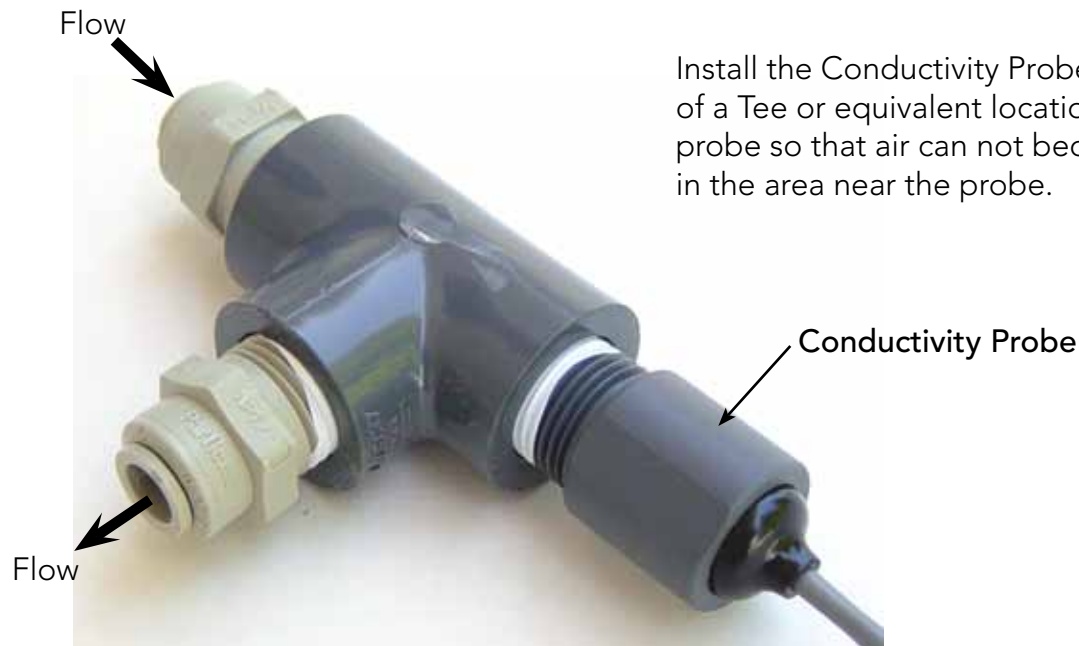


**Detailed View**



**Figure 4. Controller Detail: Terminal Board, TB-2 (See Fig. 1 for schematic)**



**Figure 5. Conductivity Probe Installation**

Install the Conductivity Probe in the "Run" of a Tee or equivalent location. Orient the probe so that air can not become trapped in the area near the probe.

### Conductivity Probe Calibration

Because the conductivity measurement is affected by the physical environment in which it operates, it is best to calibrate while installed in the system and operating under normal conditions. This requires an external conductivity measurement device that is known to be accurate to serve as a reference.

1. Operate the RO long enough for the membranes, operating temperature and permeate conductivity reading to stabilize.
2. Take a sample of the permeate and measure it with the reference meter.
3. See Figure 7 for instructions on how to access the Permeate Calibration Menu.
4. Enter the Permeate Calibration menu and use the UP or Down arrow until the value on the controller matches the value obtained on the reference meter.
5. Exit and Save the calibration.
6. The same procedure applies to the Feed Probe calibration.

NOTE: The probe calibration must be performed using solutions with conductivity of less than 900 ppm or  $\mu\text{s}$ . The conductivity calibration circuit will behave erratically if you attempt to calibrate using a higher value. When using a standard calibration solution, the NaCl PPM value can be used in place of the  $\mu\text{s}$  value if desired.

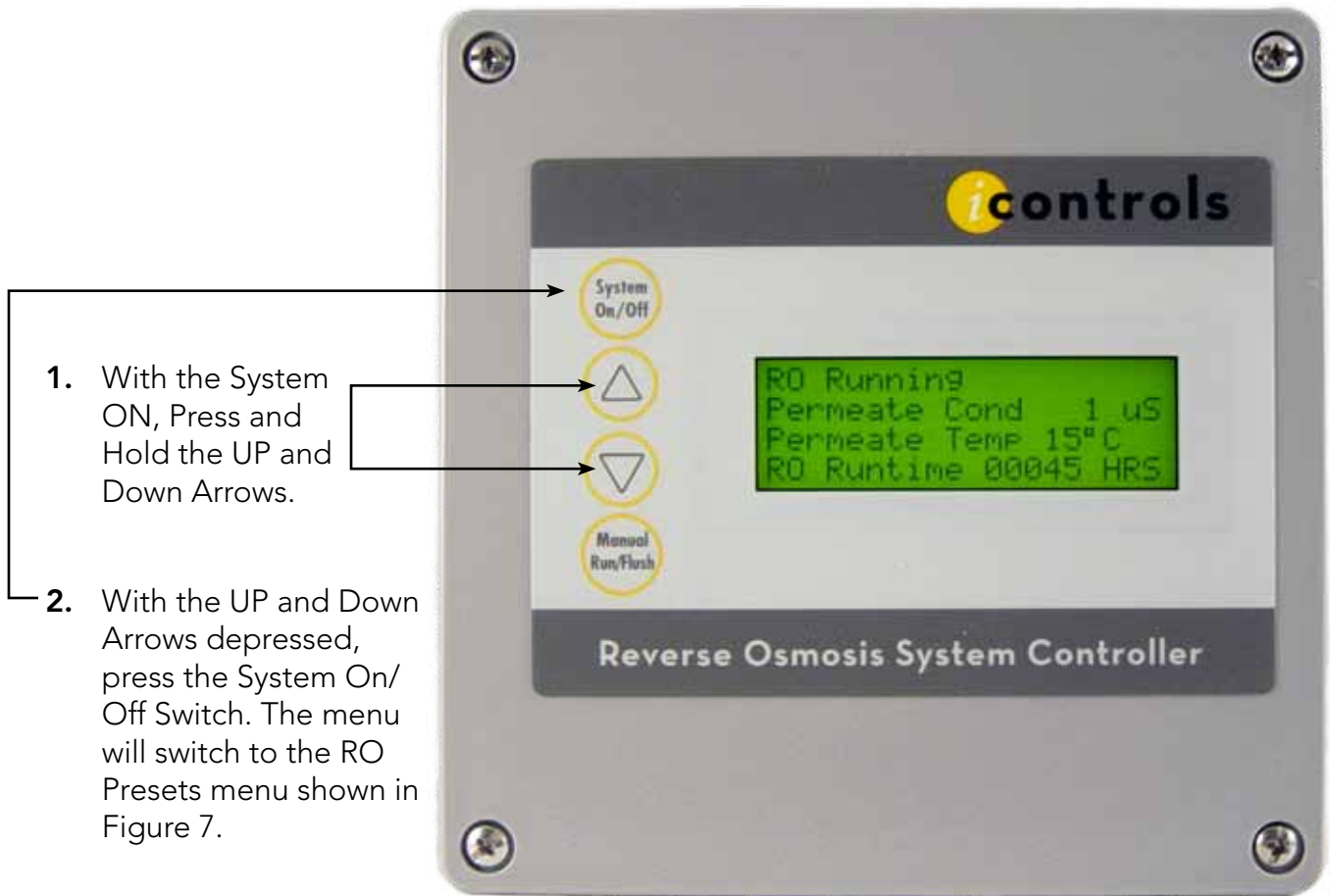
**Installation**

1. Drill the enclosure as needed and install liquid-tight fittings for the wiring.  
*NOTE: The Controller can be ordered pre-drilled or with fittings installed, or with fittings and wiring installed. Contact i-controls for details.*
2. Mount the enclosure in the desired location on the RO system.
3. Bring the wires from the peripheral devices into the enclosure and connect them to the appropriate terminals. (See Figure 1, Figure 3 and Figure 4.)
4. Set the voltage selector switch on the Terminal Board to the desired voltage (110VAC or 240VAC) (See Figure 4.)
5. Install the correct power fuse for your voltage/motor HP. See the table below. Refer to Table 1 on page for for the recommended fuse type. Refer to Figure 4 for the fuse locations..

**Controller Power Fuse Values**

	Contactor Coil	.5 HP	.75 HP	1 HP	1.5 HP
110 VAC	4 A	12 A	20 A	N/A	N/A
240 VAC		-	-	12 A	20 A

6. Install the conductivity cell in the permeate line. (See Figure 5 for conductivity cell installation instructions.)
7. Connect the conductivity cell to the terminals on the CPU Board. (See Figure 3) Repeat Steps 6 & 7 for the Feed Conductivity cell if your system will utilize both feed and permeate conductivity measurement.
8. Provide power to the RO system.
9. Press the System On/Off switch to turn the system ON.
10. Select the Program Mode (See Figure 6 and Table 2). The default is Program 1 which is a general purpose setting. Use Program 2 if your system is not equipped with a flush valve.  
*NOTE: The Program Settings can be customized to suit the specific needs of an OEM and preprogrammed at the factory with your settings. Contact i-controls for details.*
11. Make any other changes you want to the settings. Press System On/Off to save your changes.
12. The controller is now ready for service.

**Figure 6. Controller Programming. Accessing the hidden menus.**

**Table 2. Controller Programming: ROC-3 Program Selections**

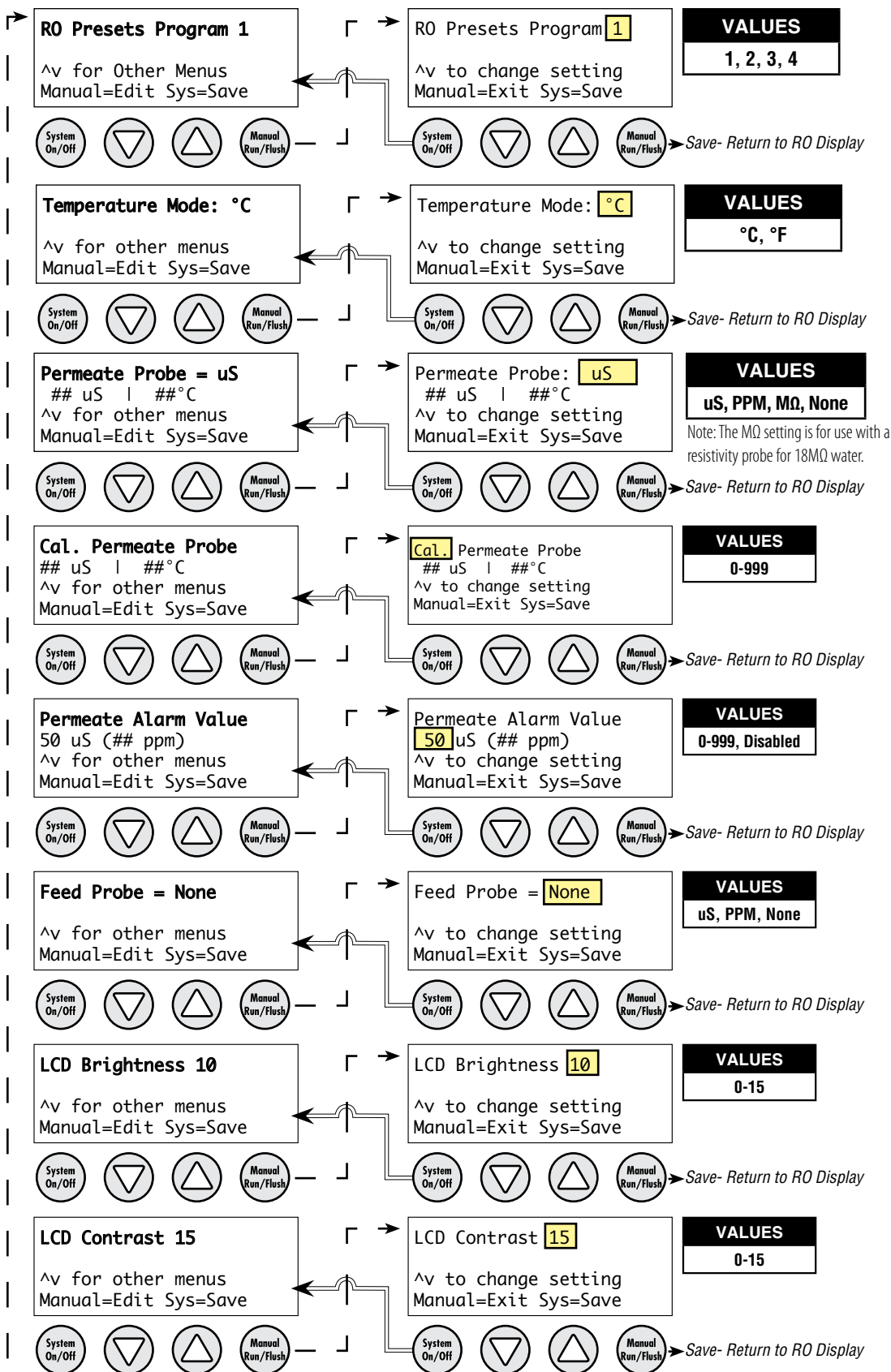
The controller has 4 separate, field-selectable sets of settings for configuring the RO. The factory default settings are shown below. The settings are identical except for variations in the flush behavior.

- For "Normal" operation use Program 1.
- For No Flush, use Program 2.
- For higher frequency and longer duration flush see Programs 3 & 4.
- See the following page for instructions on how to access the menu for selecting these programs.
- See Appendix A for a detailed explanation of the Parameters and their affect on the RO's operation.
- See Appendix B for information on the programming interface.

Parameter	Value	Program 1	Program 2	Program 3	Program 4
Tank Level Switch de-Bounce	Seconds	2.0	2.0	2.0	2.0
Pressure Switch de-Bounce	Seconds	3	3	3	3
Pretreat Switch de-Bounce	Seconds	2	2	2	2
Pump start delay	Seconds	10	10	10	10
Inlet Solenid stop delay	Seconds	1	1	1	1
Pump start retry interval (restart delay after LP fault)	Seconds	60	60	60	60
Low pressure fault shutdown, # of faults	Faults	5	5	5	5
Low pressure fault shutdown, time period to count faults	Minutes	10	10	10	10
Low pressure fault shutdown, reset after shutdown	Minutes	60	60	60	60
Low pressure fault alarm relay output (TB-2 ONLY) *	Off/On	Off	Off	Off	Off
Low pressure timeout fault	Seconds	60	60	60	60
<b>Flush Behavior</b>		Normal	No Flush	Extra Flush	Maximum Flush
Time from last flush before Flush on Shutdown	Minutes	10	0	10	10
Minimum operation before Flush on Shutdown	Minutes	30	0	30	1
Flush duration on Shutdown	Seconds	60	0	120	300
Periodic Flush interval	Minutes	60	0	60	30
Periodic Flush duration	Seconds	30	0	60	30
Unit Idle Flush interval *	Minutes	0	0	0	0
Unit Idle Flush duration *	Seconds	0	0	0	0
Timed Manual Run	Minutes	5	5	5	9
Timed Manual Flush	Minutes	5	0	5	9
Conductivity Probe Sample Rate	Seconds	2	2	2	2
Conductivity Shutdown *	Minutes	0	0	0	0

\* These features are disabled by default due to the potential for confusion on the part of end-users in the field. They can be enabled when needed via the OEM PC programming interface which allows changes to all of the values shown above.

**Figure 7. Controller Programming: Menu Navigation**



**Appendix A. Controller Programming: Parameters Explained**

Parameter	Value	Range	Example
<b>Input Switch Behaviors</b>			
Tank Level Switch de-Bounce	Seconds		2.0
<i>This specifies the time that the tank switch must be closed or open before the controller accepts it as a valid condition. The function is to prevent nuisance tripping of the RO especially in small tanks or turbulent tanks</i>			
Pressure Switch de-Bounce	Seconds		2
Pretreat Switch de-Bounce	Seconds		2
<i>This is the time that the pretreat switch must be OPEN before the controller accepts it as a valid condition. The function is to prevent nuisance tripping of the RO especially in small tanks or turbulent tanks</i>			
<b>Pump/Inlet Solenoid Behaviors</b>			
Pump start delay	Seconds		10
<i>On RO start-up, after the tank switch opens, the inlet solenoid valve is energized. When the inlet pressure switch closes this begins the "Pump start delay". If the pressure switch remains closed, the pump will start after 10 seconds.</i>			
Inlet Solenoid stop delay	Seconds		1
<i>This value sets the delay for the inlet solenoid valve to be deenergized following the deenergizing of the motor on RO shut down. The purpose is to prevent the pump from operating against a closed suction as the pump spins down.</i>			
<b>Low Inlet Pressure Behaviors</b>			
Pump start retry interval (restart delay after LP fault)	Seconds		60
<i>When the inlet pressure switch opens, the controller deenergizes the motor and the inlet solenoid valve remains open. The controller will continue to monitor the inlet pressure switch. After the switch is closed for the duration of the "Pump start retry interval" the motor is reenergized.</i>			
Low pressure fault shutdown, # of faults	Faults		5
Low pressure fault shutdown, time period to count faults	Minutes		10
Low pressure fault shutdown, reset after shutdown (0 value = no restart)	Minutes		60
<i>These three values work together to determine how the RO handles Low Pressure conditions. The first two values, "# of faults" and "time period to count faults", sets the limit for the number of low fault conditions over time that are required to place the RO in "Low Pressure Fault Shutdown". The third value sets the duration of the "Low Pressure Fault Shutdown" which is the period that the RO will remain idle before trying to restart. The purpose of the Low Pressure Fault Shutdown is to prevent an RO from turning OFF/ON repeatedly without any limit.</i>			
Low pressure timeout fault	Seconds		60
<i>If the inlet valve is open, but the pressure isn't sufficient to close the inlet pressure switch, the RO would run indefinitely on line pressure. This value sets the time limit for the RO to operate with the inlet valve open with Low Pressure as indicated by an Open inlet pressure switch before a Low Pressure Fault is added to the counter above</i>			

**Appendix A. Controller Programming: Parameters Explained**

<b>Flush Behavior</b>			
Time from last flush before Flush on Shutdown	Minutes		15
Minimum operation before Flush on Shutdown	Minutes		60
Flush duration on Shutdown	Seconds		60
Periodic Flush interval	Minutes		60
Periodic Flush duration	Seconds		30
Unit Idle Flush interval *	Minutes		0
<i>The Unit Idle Flush Interval sets a time after which the RO will start-up and run in the flush mode. This is disabled by default because of the danger of over-flowing a tank if not properly implemented. It is intended for environments where leaving the RO idle for long periods would invite bio-fouling. (0)=disabled</i>			
Unit Idle Flush duration *	Seconds		0
<i>Sets the duration of the Idle Flush. (0)=disabled</i>			
Timed Manual Run - Duration of Manual Run	Minutes		5
Timed Manual Flush - Duration of Manual Flush	Minutes		5
Conductivity Probe Sample Rate	Seconds		2
Conductivity Shutdown * (0)=disabled	Minutes		0

## Controller Fault Condition Displays

Below are examples and explanations of the displays which accompany the fault conditions possible in the ROC-3. Fault conditions always indicated a problem of some sort which requires corrective action. the displays provide sufficient information to recognize the source of the fault and the required corrective action.

**High Pressure Fault:** *(Occurs when High Pressure Switch Closes)*

Line 1 "Service Fault"  
Line 2 "High System Pressure"  
Line 3  
Line 4 "To Reset Push OFF/ON"

**Low Pressure Fault:** *(System is responding to low pressure condition per system settings)*

Line 1 "Service Fault"  
Line 2 "Low Feed Pressure"  
Line 3  
Line 4 "Restart in MM:SS"

**Pre Treat Fault:** *(Pretreat Switch is closed indicating problem with pretreat system).*

Line 1 "Service Fault"  
Line 2 "Pretreat"  
Line 3  
Line 4 "Check Pretreat Sys."

**Permeate Conductivity Fault:** *(Permeate conductivity is higher than the alarm setpoint.)*

Line 1 "Service Fault"  
Line 2 "Permeate TDS xxx ppm" or "Permeate Cond xxx uS"  
Line 3 "Alarm SP xxx ppm" or "Alarm SP xxx uS"  
Line 4 "To Reset Push OFF/ON"

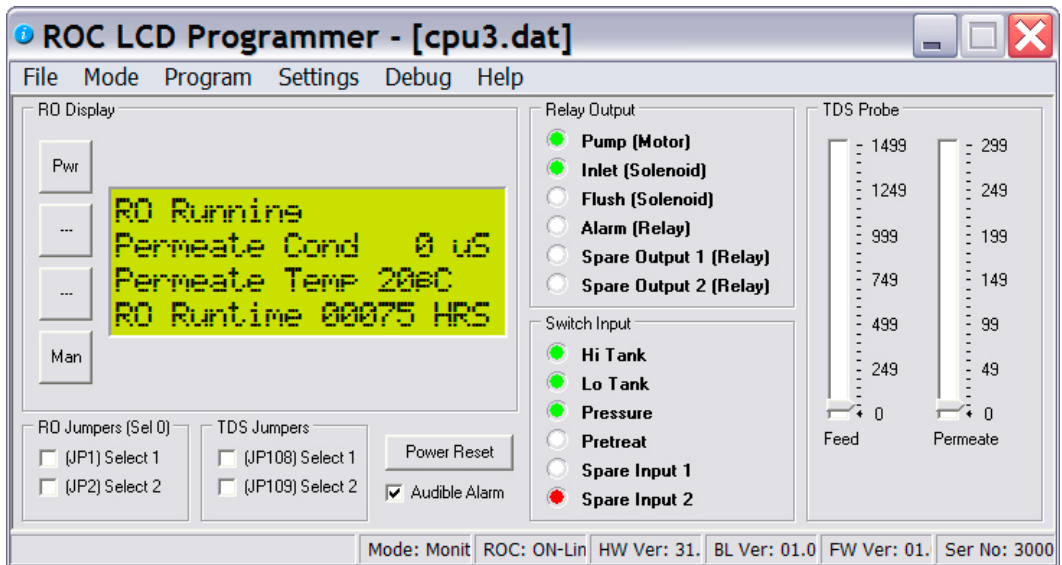
**Feed Conductivity Fault:** *(Feed conductivity is higher than the alarm setpoint.)*

Line 1 "Service Fault"  
Line 2 "Feed TDS xxx ppm" or "Feed Cond xxx uS"  
Line 3 "Alarm SP xxx ppm" or "Alarm SP xxx uS"  
Line 4 "To Reset Push OFF/ON"

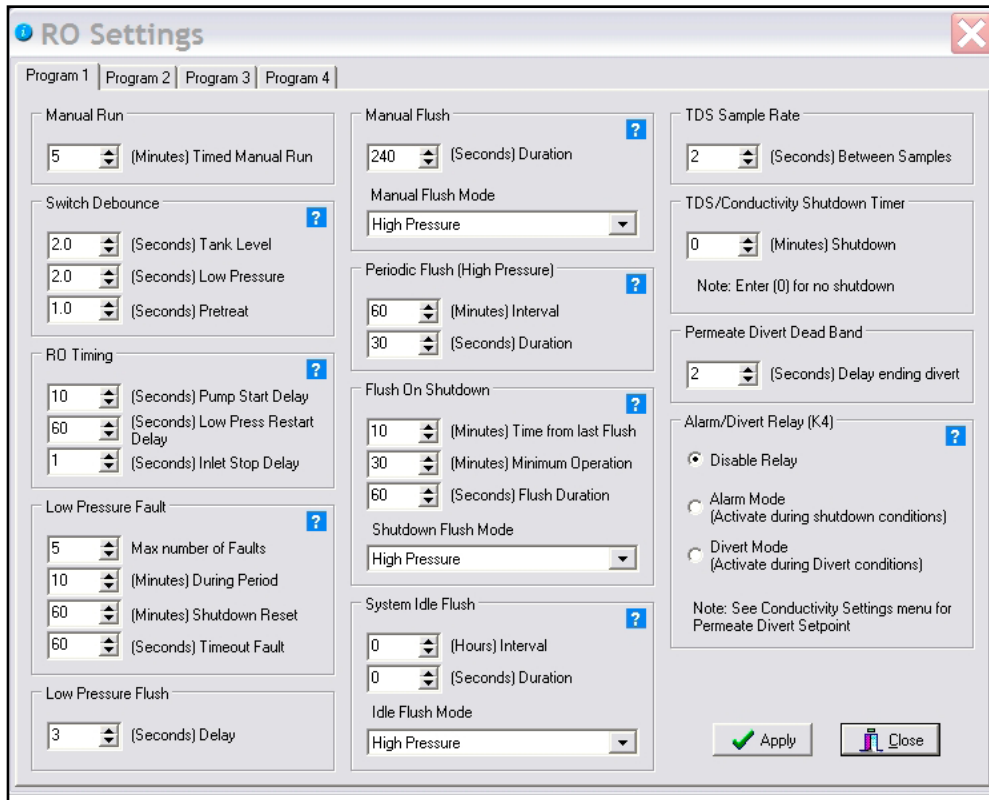
**Conductivity Probe Error messages:**

Line 2 "Over-range" - Measurement is out of range for the circuit, probe may also be shorted  
Line 2 "Probe shorted" - Short circuit detected on temperature sensor in probe  
Line 2 "Probe not detected" - Open circuit detected on temperature sensor in probe  
Line 2 "Probe Startup 1" - Internal reference voltage too high to make valid measurement  
Line 2 "Probe Startup 2" - Internal reference voltage too low to make valid measurement  
Line 2 "Probe Startup 3" - Internal excitation voltage too high to make valid measurement  
Line 2 "Probe Startup 4", - Internal excitation voltage too low to make valid measurement

**Appendix B. Controller Programming: Programming Interface Overview**



The ROC programming interface is a Windows-based tool for making changes to the ROC software. The program combines a simulator for testing your changes on the PC and an communications/programming interface for loading the software into the controller. The Interface can also be used to remotely monitor the RO.



This screen shows the RO settings available. There are 4 different sets of settings stored in the CPU-3

## Appendix C. Warranty

### I-Controls Limited Warranty

#### What the warranty covers:

*i-controls* warrants the ROC-3 to be free from defects in materials and workmanship during the warranty period. If a product proves to be defective during the warranty period, *i-controls* will at its sole option repair or replace the product with a like product. Replacement product or parts may include remanufactured or refurbished parts or components.

#### How long the warranty is effective:

The ROC-3 is warranted for one (1) year for parts and labor from the date of the first consumer purchase or 15 months from ship date, whichever comes first.

#### What the warranty does not cover:

1. Damage, deterioration or malfunction resulting from:
  - a. Accident misuse, neglect, fire, water lightning or other acts of nature, unauthorized product modification or failure to follow instructions supplied with the product.
  - b. Repair or attempted repair by anyone not authorized by *i-controls*
  - c. Any damage of the product due to shipment.
  - d. Causes external to the product such as electric power fluctuations.
  - e. Use of supplies or parts not meeting *i-controls*' specifications.
  - f. Normal wear and tear.
  - g. Any other cause which does not relate to a product defect.
2. Transportation costs necessary to obtain service under this warranty.
3. Labor other than factory labor.

#### How to get service:

1. To obtain warranty service, contact *i-controls* for a Return Material Authorization (RMA).
2. You will be required to provide:
  - a. Your name and address
  - b. A description of the problem
3. Package the controller carefully for shipment and return it to *i-controls*, freight prepaid.

#### Limitation of implied warranties:

There are no warranties, expressed or implied, which extend beyond the description contained herein including the implied warranty of merchantability and fitness for a particular purpose.

#### Exclusion of damages:

*i-controls*' liability is limited to the cost of repair or replacement of the product. *i-controls* shall not be liable for:

1. Damage to other property caused by any defects in the product, damages based upon inconvenience, loss of use of the product, loss of time, loss of profits, loss of business opportunity, loss of goodwill, interference with business relationships or other commercial loss, even if advised of the possibility or such damages.
2. Any other damages, whether incidental, consequential or otherwise.
3. Any claim against the customer by any other party.

#### Effect of state law:

This warranty gives you specific legal rights, and you may also have other rights which vary from state to state. Some states do not allow limitations on implied warranties and/or do not allow the exclusion of incidental or consequential damages, so the above limitations and exclusions may not apply to you.